



# X143IP Intermediate Power Generator Quick Start Instructions

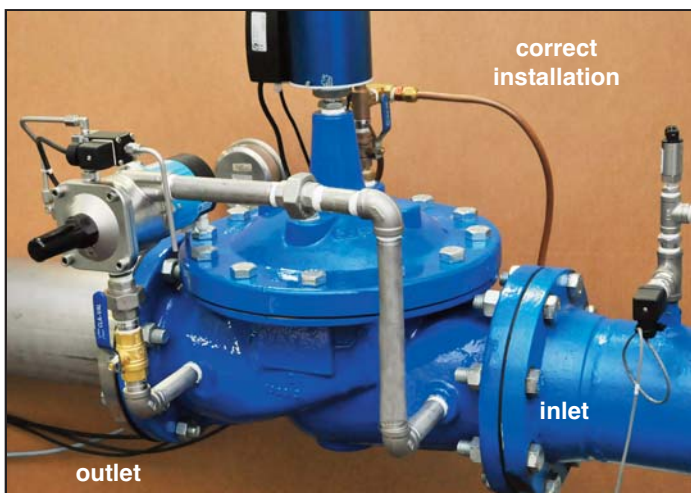
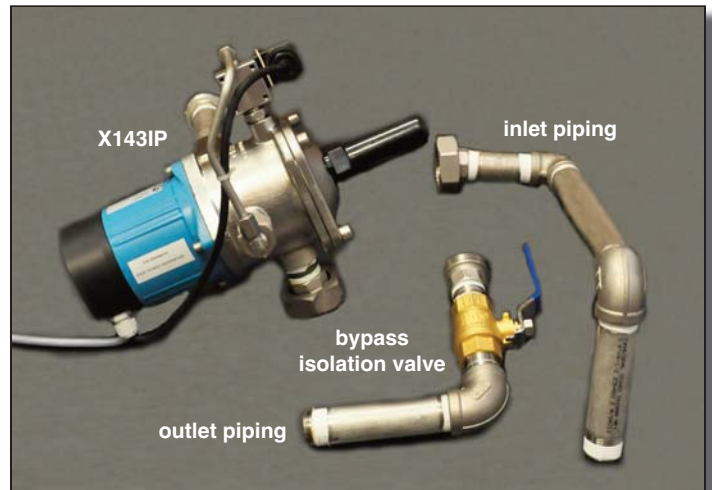
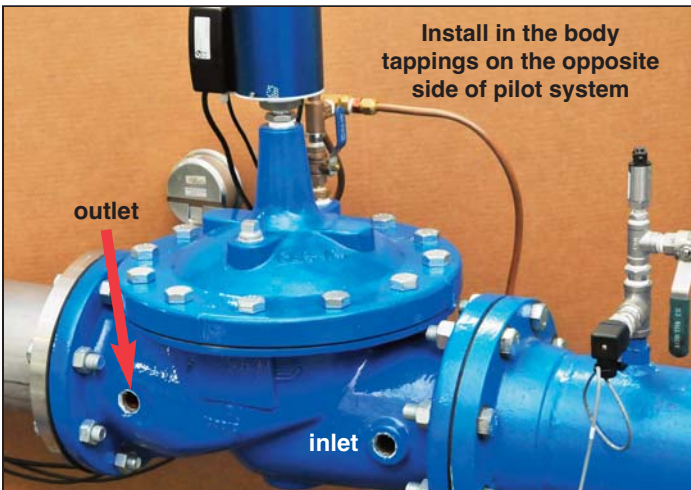
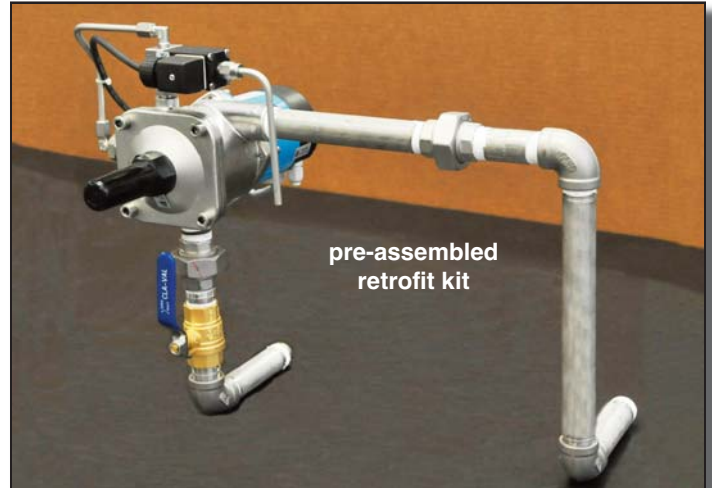
## X143IP Intermediate Power Generator Mounting Instructions

### X143IP Power Generator Retrofit Kit

The pre-assembled X143IP Intermediate Power Generator Retrofit Kit contains the following component assemblies, and is shipped ready to mount on a Cla-Val Automatic Control Valve.

- X143IP Power Generator
- 3/4-inch inlet piping assembly
- 3/4-inch outlet piping assembly

for technical assistance, call  
800.942.6326 or log-on to  
[www.cla-val.com](http://www.cla-val.com)



### SAFETY PRECAUTION

**Isolate the control valve using main line isolation valves and bleed pressure before removing body plugs**

**Step 1:** Unthread inlet and outlet piping from pre-assembled retrofit kit

**Step 2:** Thread inlet piping into inlet tapping and outlet piping into outlet tapping

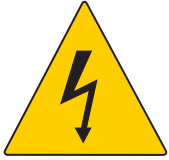
**Step 3:** Install X143IP Power generator onto outlet piping

**Step 4:** Make electrical connections as described in the Wiring Instructions on page 2; Proceed with Start-Up as described on page 3



# X143IP Intermediate Power Generator Quick Start Instructions

## Wiring Instructions



### IMPORTANT SAFETY PRECAUTION

Before making any wiring connections in the electrical box, please take the following precautions:

- Ensure that the isolation valve on the **bypass is closed** so that the turbine cannot be engaged
- Confirm that the **battery is disconnected**
- Confirm that the LED on the PCB is **not blinking**

- Terminal 1: +12 VDC; Terminal 2: 0V
- Terminal 3: +24 VDC; Terminal 4: 0V
- Terminal 5 and Terminal 6: Alarm battery (dry contact relay closure)



Figure 1: X143IP

Make electrical connections as shown in Figure 2.

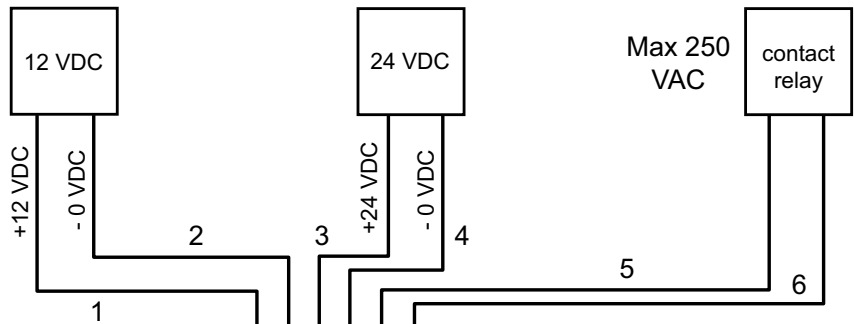


Figure 3:

The removable terminal strip with Terminals 1 - 10 makes connections easier

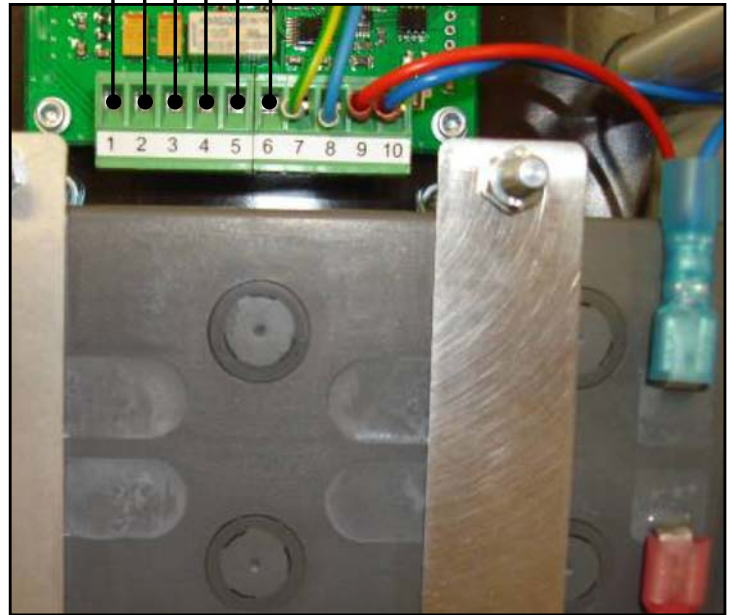


Figure 2: Terminal Connections



# X143IP Intermediate Power Generator Quick Start Instructions

## Start-Up Instructions

- Once the electrical connection is complete, connect the battery:
  - Red cable to Terminal +
  - Blue cable to Terminal -
- Open the isolation valve on the bypass directly after connecting the battery.
  - The turbine will start to run and the differential pressure controller will start to regulate
- Check that the LED inside the Control Box flashes either red or green (see Figure 4).
  - The first minute is a starting cycle where the solenoid discharges to atmosphere two times
- Check that the X143IP Power Generator is powering the desired electronic devices
- Close the electrical box with the six screws provided
- The X143IP Intermediate Power Generator is commissioned and ready to be used



Figure 4: LED

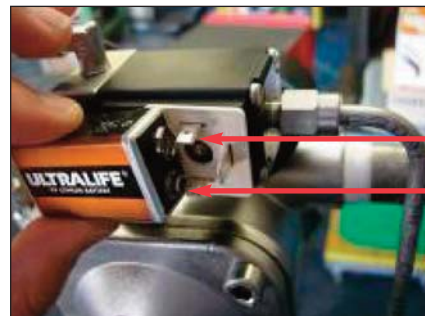
## Measuring differential pressure across the turbine

- Close the isolation valve in the bypass to stop the turbine
- Remove the removable terminal block with Terminals 1 to 10 (see page 2, Figure 3)
- Remove the solenoid connector using a screwdriver (see Figure 5)
- Switch the solenoid with a 9 Volt 6LR61 battery as shown (see Figure 6)
- Open the isolation valve on the bypass to engage the turbine
- Measure the AC voltage of the turbine as shown (see Figure 7)
- See page 4, Figure 8 for proper operational parameters

Figure 5: Solenoid Connector

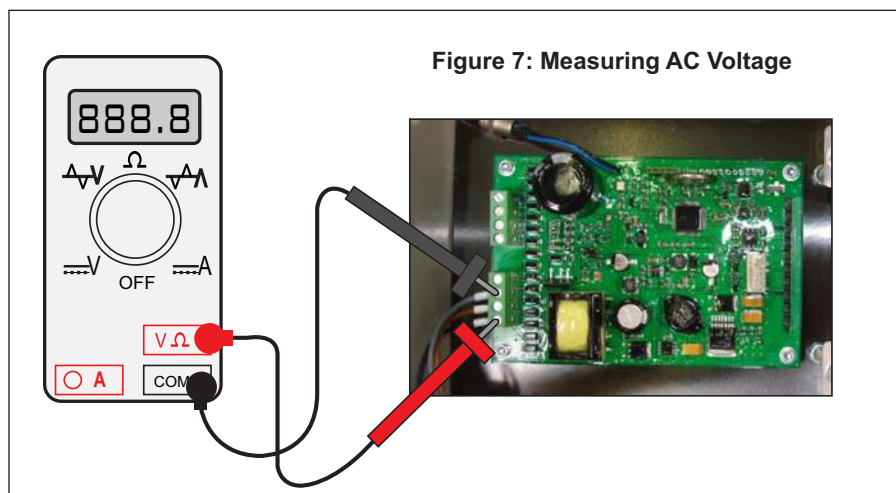


Figure 6: Battery Connection



Pole -  
Pole +

Figure 7: Measuring AC Voltage



Use extreme caution  
when operating the  
X143IP with Control  
Box cover open



**WARNING**  
High AC  
Voltage

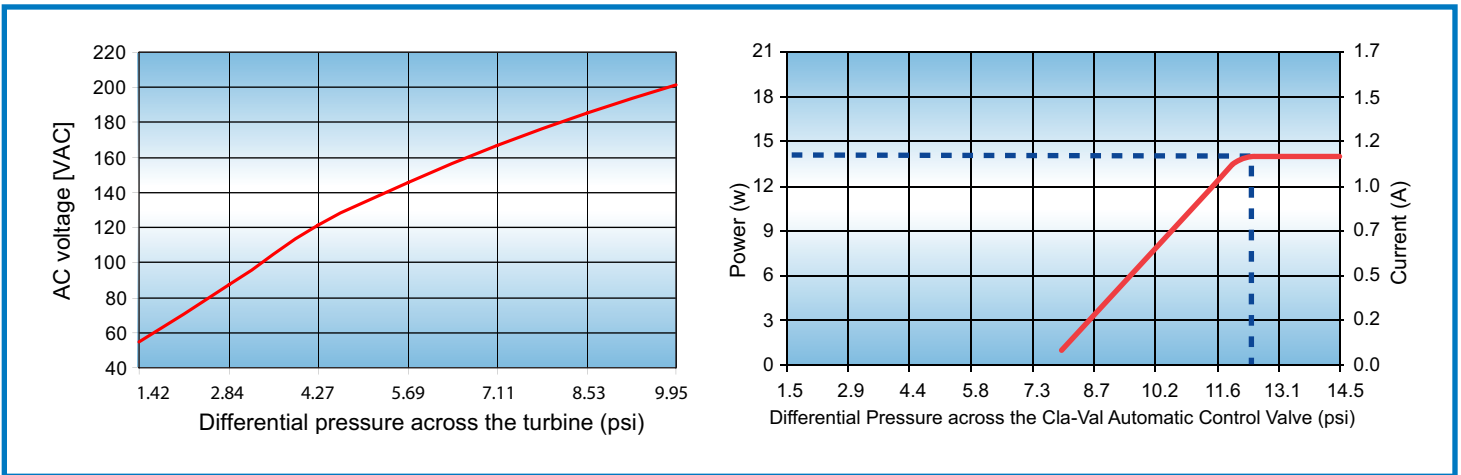


# X143IP Intermediate Power Generator Quick Start Instructions

## Attaining Optimal Performance

- For optimum functioning of the X143IP Power Generator, the AC voltage of the turbine should be between 185 and 200 VAC
- If the AC voltage is lower, please refer to the chart below see (Figure 8) to find your differential pressure across the turbine
- This differential pressure allows you to know the maximum power delivered from the X143IP Power Generator. With this information, you can evaluate power generated versus power consumed

Figure 8 Differential Pressure Across X143IP Turbine



Output Voltage	<b>Amp Continuous (60 min/h)</b>	Amps Low Peak (10 min/h)	Amps High Peak (1 min/h)
12 V	<b>1.2 A</b> <b>14 W</b>	3 A 36 W	5 A 60 W
24 V (step-up)	<b>0.6 A</b> <b>14 W</b>	1.5 A 36 W	2.5 A 60 W

### Typical Installations: Underground Vault/Pressure Reducing Stations

